

TOP VIEW
SCALE:1/8

U-TYPE ANCHOR
4690 LBS X 3/8" X 7"

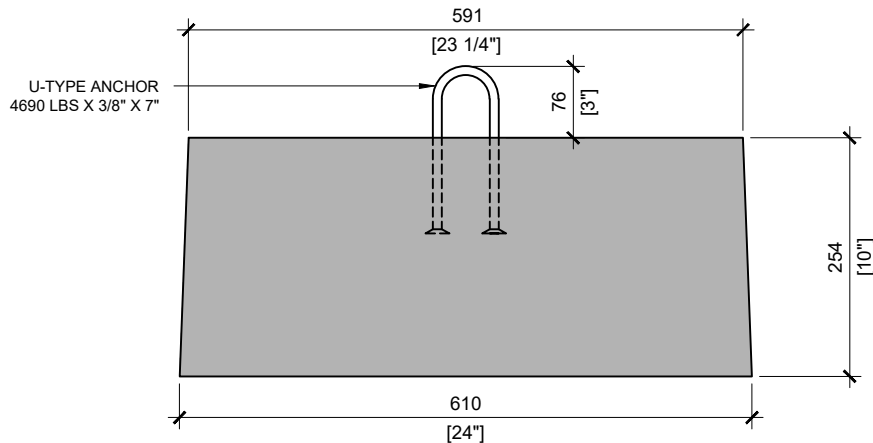

FRONT VIEW
SCALE:1/6

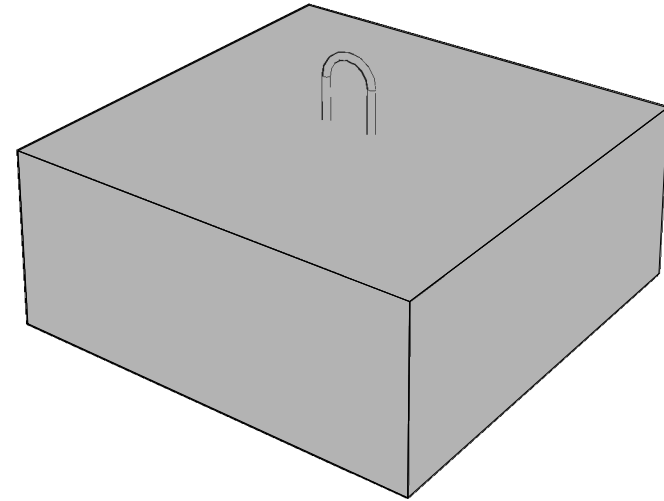
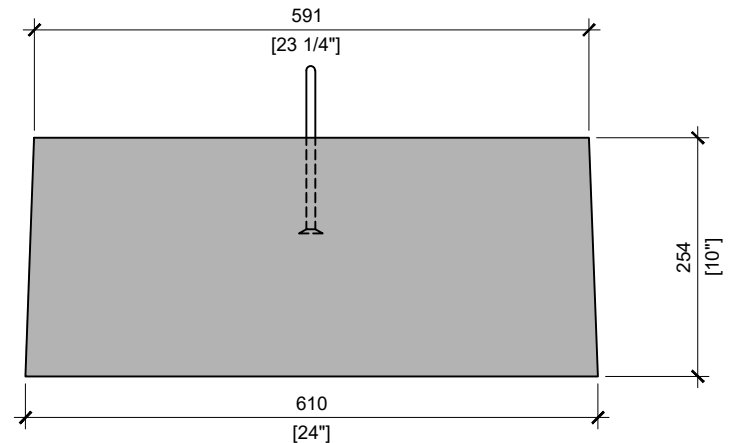

RIGHT VIEW
SCALE:1/6



MANUFACTURED:
LINDSAY, ON
1-800-655-3430

UNIT WEIGHT:
MARINE ANCHOR: 500lbs / 227kgs

DRAWN BY:
SR

DATE:
DEC/2023

500LB MARINE ANCHOR