

TOP VIEW
SCALE:1/30

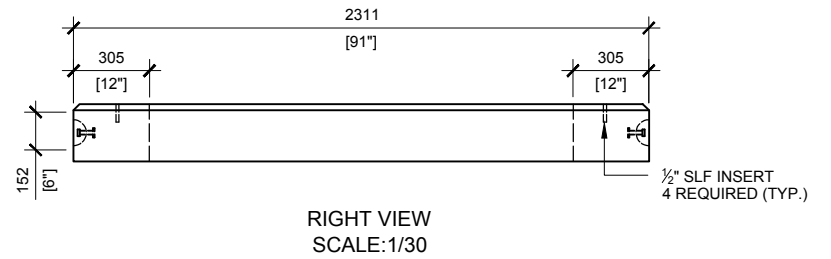

RIGHT VIEW
SCALE:1/30

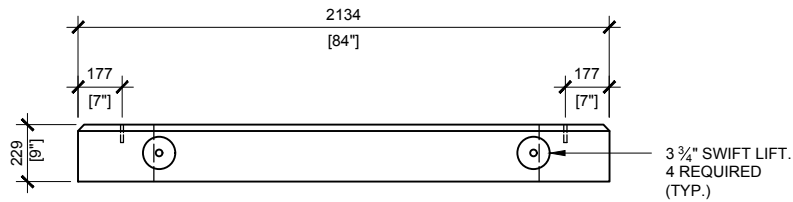
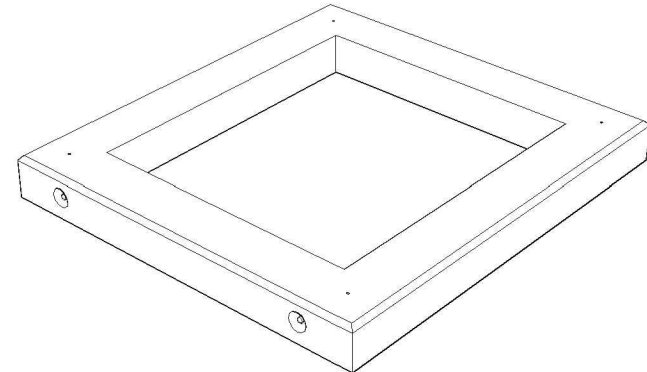

FRONT VIEW
SCALE:1/30

GENERAL NOTES:

1. DELIVERY IS MADE BY CRANE-EQUIPPED TRUCKS
2. EXCAVATION MUST BE READY, SAFE AND ACCESSIBLE FOR UNLOADING FROM THE REAR OF THE TRUCK.
3. MIN OVERHEAD CLEARANCE OF 18FT IS REQUIRED
4. ALL UNITS MUST BE HANDLED WITH PROPER LIFTING EQUIPMENT (I.E. SPREADER BAR)



MANUFACTURED:
BROOKLIN, ON
1-800-655-3430

CONCRETE: 35MPa / 5,000PSI
AIR ENTRAINMENT: 6-8%
REINFORCEMENT : STEEL TO CSA
CAN A23.1 / A23.3. G30.18 Fy=400MPa

WEIGHT:
BCP330BC9 - 2,825lbs / 1,280kg

DRAWN BY:
S.RIMLAND

DATE:
AUG/2017

BCP330BC9

BASE COLLAR FOR PRECAST FOUNDATION