

TOP VIEW
SCALE: 1/30

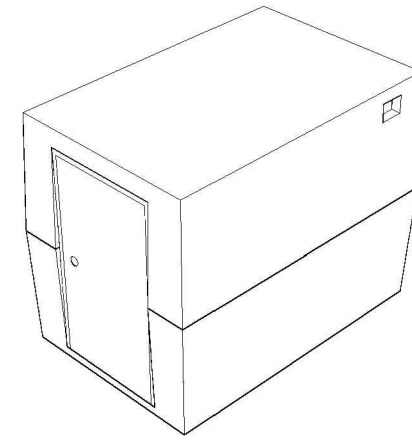

GENERAL NOTES:

1. DELIVERY IS MADE BY CRANE-EQUIPPED TRUCKS
2. SITE MUST BE READY, SAFE AND ACCESSIBLE FOR UNLOADING FROM THE REAR OF THE TRUCK
3. MIN OVERHEAD CLEARANCE OF 18FT IS REQUIRED
4. ALL UNITS MUST BE HANDLED WITH PROPER LIFTING EQUIPMENT (I.E. SPREADER BAR)

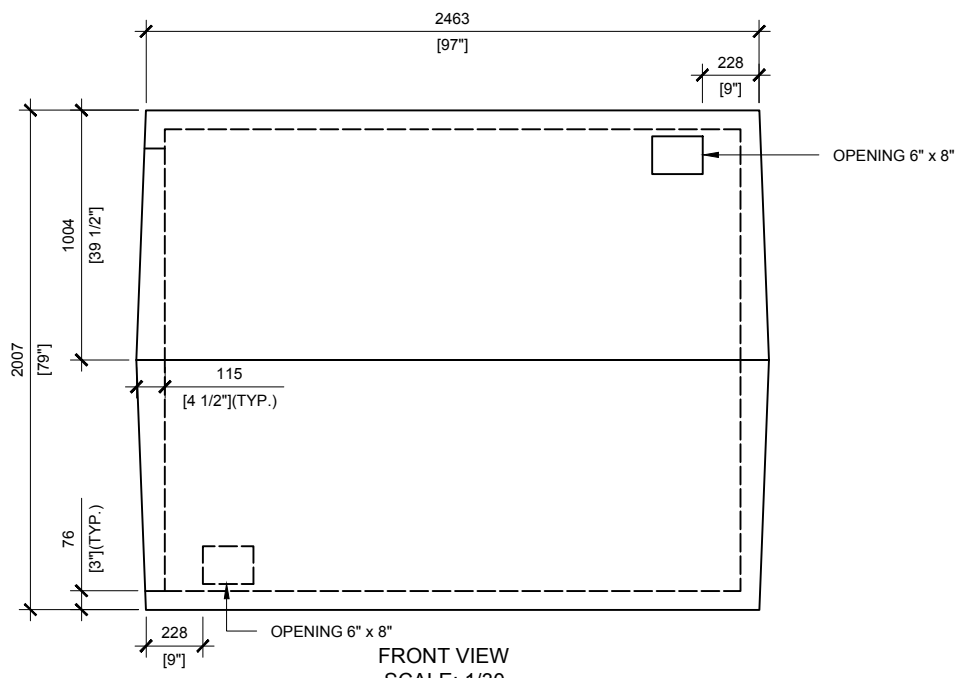

FRONT VIEW
SCALE: 1/30

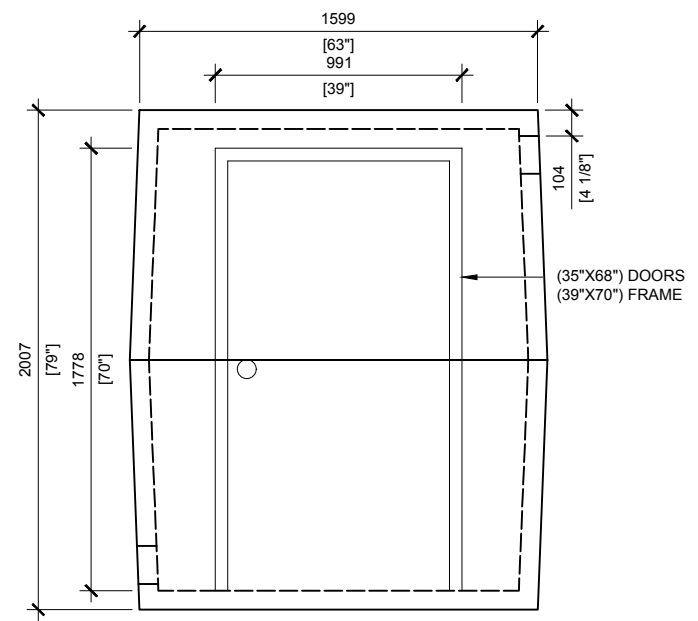

LEFT VIEW
SCALE: 1/30



MANUFACTURED:
BROOKLIN, ON
1-800-655-3430

CONCRETE: 35MPa / 5,000PSI
AIR ENTRAINMENT: 6-8%
REINFORCEMENT: STEEL TO CSA
CAN A23.1 / A23.3. G30.18 Fy=400MPa

WEIGHT:
MODEL 40 - 9,000lbs / 4,082kg

DRAWN BY:
S.RIMLAND

DATE:
AUG/2017

MODEL 40

PRECAST CONCRETE UTILITY BUILDING WITH DOOR
TYPICAL USE: ABOVE GROUND ELECTRICAL ROOM